



HIGH PERFORMANCE BATTERY

DRY CHARGED BATTERY



このバッテリーの品質は日本と同様です。 JAPAN STANDARD

ISO 9001 Certified
ISO/TS 16949 Certified



SNI 0038-2009
LSPR-004-IDN

▼ JIS Battery Specification



OLD JIS	NEW JIS	VOLT (V)	CAPACITY		RESERVE CAPACITY (min.)	CCA SAE (Amp) at -18°C	DIMENSION (mm)				CELL LAYOUT	HANDLE	TERMINAL SHAPE	ACID VOLUME APPROX. (L)
			20 HR (Ah)	5 HR (Ah)			LENGTH	WIDTH	HEIGHT	TOTAL HEIGHT				
NS40	32B20R	12	32	26	37	225	196	127	203	226	1	MOVE	B	2.8
NS40L	32B20L	12	32	26	37	225	196	127	203	226	0	MOVE	B	2.8
NS40Z	36B20R	12	35	28	45	260	196	127	203	226	1	MOVE	B	2.6
NS40ZL	36B20L	12	35	28	45	260	196	127	203	226	0	MOVE	B	2.6
NT60-S4	38B20R	12	38	30	55	275	196	127	203	226	1	MOVE	B	2.6
NT60-S4L	38B20L	12	38	30	55	275	196	127	203	226	0	MOVE	B	2.6
N40	32C24R	12	40	32	45	250	236	128	202	225	1	MOVE	A	3.5
N40L	32C24L	12	40	32	45	250	236	128	202	225	0	MOVE	A	3.5
NS60	46B24R	12	45	36	58	295	236	128	202	225	1	MOVE	B	3.3
NS60L	46B24L	12	45	36	58	295	236	128	202	225	0	MOVE	B	3.3
NS60S	46B24RS	12	45	36	58	295	236	128	202	225	1	MOVE	A	3.3
NS60LS	46B24LS	12	45	36	58	295	236	128	202	225	0	MOVE	A	3.3
NX100-6	55B24R	12	50	40	65	300	236	128	202	225	1	MOVE	B	3.2
NX100-6L	55B24L	12	50	40	65	300	236	128	202	225	0	MOVE	B	3.2
NX100-6S	55B24RS	12	50	40	65	300	236	128	202	225	1	MOVE	A	3.2
NX100-6LS	55B24LS	12	50	40	65	300	236	128	202	225	0	MOVE	A	3.2
	55D23R	12	60	48	82	340	227	172	201	221	1	MOVE	A	4.3
	55D23L	12	60	48	82	340	227	172	201	221	0	MOVE	A	4.3
N50	48D26R	12	50	40	72	290	256	172	204	227	1	MOVE	A	5.5
N50L	48D26L	12	50	40	72	290	256	172	204	227	0	MOVE	A	5.5
N50Z	55D26R	12	60	48	82	340	256	172	204	227	1	MOVE	A	5.3
N50ZL	55D26L	12	60	48	82	340	256	172	204	227	0	MOVE	A	5.3
NS70	65D26R	12	65	52	93	400	256	172	204	227	1	MOVE	A	5.0
NS70L	65D26L	12	65	52	93	400	256	172	204	227	0	MOVE	A	5.0
NX110-5	80D26R	12	68	54	103	490	256	172	204	227	1	MOVE	A	4.9
NX110-5L	80D26L	12	68	54	103	490	256	172	204	227	0	MOVE	A	4.9
N70	65D31R	12	70	56	115	425	304	172	205	228	1	MOVE	A	6.1
N70L	65D31L	12	70	56	115	425	304	172	205	228	0	MOVE	A	6.1
N70Z	75D31R	12	75	60	118	450	304	172	205	228	1	MOVE	A	6.0
N70ZL	75D31L	12	75	60	118	450	304	172	205	228	0	MOVE	A	6.0
NX120-7	95D31R	12	80	64	135	565	304	172	205	228	1	MOVE	A	5.7
NX120-7L	95D31L	12	80	64	135	565	304	172	205	228	0	MOVE	A	5.7
N100	95E41R	12	100	80	150	525	406	174	210	232	1	DROP DOWN	A	8.1
N120	115F51	12	120	96	200	625	507	180	210	237	3	ROPE	A	9.0
N150	145G51	12	150	120	250	725	508	222	209	237	3	DROP DOWN	A	13.0
N200	190H52	12	200	160	370	875	517	279	219	246	3	DROP DOWN	A	15.1

▼ DIN Battery Specification



DIN TYPE	VOLT (V)	CAPACITY 20 HR (Ah)	RESERVE CAPACITY (min.)	CCA SAE (Amp) at -18°C	DIMENSION (mm)				CELL LAYOUT	HANDLE	TERMINAL SHAPE	ACID VOLUME APPROX. (L)
					LENGTH	WIDTH	HEIGHT	TOTAL HEIGHT				
54433	12	44	65	290	208	175		187	0	MOVE	A	3.6
54519	12	45	81	300	241	174		170	0	MOVE	A	2.9
55530	12	55	82	350	241	175		184	0	MOVE	A	3.5
56048	12	60	90	370	241	175		184	0	MOVE	A	3.3
56618	12	66	93	400	273	172		189	0	MOVE	A	4.8
58024	12	80	125	450	273	172		189	0	MOVE	A	4.5
58827	12	88	135	525	352	176		189	0	MOVE	A	6.4
60038	12	100	160	580	352	176		189	0	MOVE	A	6.1
62034	12	120	190	750	513	190	192	218	4	ROPE	A	11.3
64020	12	140	220	800	513	190	192	218	4	ROPE	A	11.0
67018	12	170	350	1,100	512	221	195	203	4	ROPE	A	11.8
68024	12	180	380	1,150	512	221	195	203	4	ROPE	A	11.5
70027	12	200	390	1,250	517	274	195	203	4	ROPE	A	17.2
72025	12	220	430	1,300	517	274	195	203	4	ROPE	A	15.8

▼ Motorcycle Battery Specification



BATTERY TYPE	VOLT (V)	CAPACITY 10 HR (Ah)	DIMENSION (mm)				CELL LAYOUT	HANDLE	ACID VOLUME APPROX. (L)
			LENGTH	WIDTH	HEIGHT	TOTAL HEIGHT			
GM3-3B/YB3L-3B	12	3	108	56		110	0	NO HANDLE	0.23
GM4-3B/YB4L-3B	12	4	130	70		92	0	NO HANDLE	0.29
GM5Z-3B/YB5L-3B	12	7	130	60		130	0	NO HANDLE	0.36
12N5-3B	12	5	130	60		130	0	NO HANDLE	0.39
12N10-3B	12	10	148	90		145	0	NO HANDLE	0.72

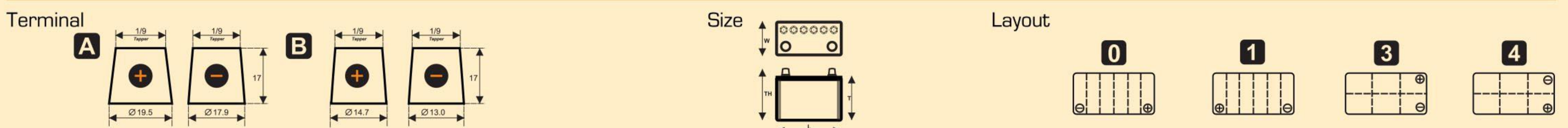

▼ JIS Battery Packaging



OLD JIS	NEW JIS	BOX DIMENSION (mm)			VOLUME M ³	BATTERY QTY. PER 20FT CONTAINER	PALLET DIMENSION (mm)		
		LENGTH	WIDTH	HEIGHT			LENGTH	WIDTH	HEIGHT
NS40	32B20R	215	141	257	0.007791	2940	1100	1100	140
NS40L	32B20L	215	141	257	0.007791	2940	1100	1100	140
NS40Z	36B20R	215	141	257	0.007791	2940	1100	1100	140
NS40ZL	36B20L	215	141	257	0.007791	2940	1100	1100	140
NT60-S4	38B20R	215	141	257	0.007791	2940	1100	1100	140
NT60-S4L	38B20L	215	141	257	0.007791	2940	1100	1100	140
N40	32C24R	254	140	263	0.009352	2240	1100	1100	140
N40L	32C24L	254	140	263	0.009352	2240	1100	1100	140
NS60	46B24R	254	140	263	0.009352	2240	1100	1100	140
NS60L	46B24L	254	140	263	0.009352	2240	1100	1100	140
NS60S	46B24RS	254	140	263	0.009352	2240	1100	1100	140
NS60LS	46B24LS	254	140	263	0.009352	2240	1100	1100	140
NX100-6	55B24R	254	140	263	0.009352	2240	1100	1100	140
NX100-6L	55B24L	254	140	263	0.009352	2240	1100	1100	140
NX100-6S	55B24RS	254	140	263	0.009352	2240	1100	1100	140
NX100-6LS	55B24LS	254	140	263	0.009352	2240	1100	1100	140
	55D23R	242	183	263	0.011647	1620	1100	1100	140
	55D23L	242	183	263	0.011647	1620	1100	1100	140
N50	48D26R	275	184	257	0.013004	1680	1100	1100	140
N50L	48D26L	275	184	257	0.013004	1680	1100	1100	140
N50Z	55D26R	275	184	257	0.013004	1680	1100	1100	140
N50ZL	55D26L	275	184	257	0.013004	1680	1100	1100	140
NS70	65D26R	275	184	257	0.013004	1680	1100	1100	140
NS70L	65D26L	275	184	257	0.013004	1680	1100	1100	140
NX110-5	80D26R	275	184	257	0.013004	1680	1100	1100	140
NX110-5L	80D26L	275	184	257	0.013004	1680	1100	1100	140
N70	65D31R	321	184	270	0.015947	1470	1100	1100	140
N70L	65D31L	321	184	270	0.015947	1470	1100	1100	140
N70Z	75D31R	321	184	270	0.015947	1470	1100	1100	140
N70ZL	75D31L	321	184	270	0.015947	1470	1100	1100	140
NX120-7	95D31R	321	184	270	0.015947	1470	1100	1100	140
NX120-7L	95D31L	321	184	270	0.015947	1470	1100	1100	140
N100	95E41R	423	186	277	0.021794	980	1100	1100	140
N120	115F51	524	200	257	0.026934	720	1100	1100	140
N150	145G51	527	234	271	0.033419	480	1100	1100	140
N200	190H52	534	285	277	0.042157	480	1100	1100	140

▼ DIN Battery Packaging



DIN TYPE	BOX DIMENSION (mm)			VOLUME M ³	BATTERY QTY. PER 20FT CONTAINER	PALLET DIMENSION (mm)		
	LENGTH	WIDTH	HEIGHT			LENGTH	WIDTH	HEIGHT
54433	225	187	235	0.007791	1920	1100	1100	140
54519	258	186	228	0.009888	1920	1100	1100	140
55530	258	187	242	0.010941	1920	1100	1100	140
56048	258	187	242	0.011676	1920	1100	1100	140
56618	296	187	227	0.011676	1680	1100	1100	140
58024	296	187	227	0.012565	1680	1100	1100	140
58827	369	188	241	0.012565	1260	1100	1100	140
60038	369	188	241	0.016719	1260	1100	1100	140
62034	530	202	257	0.016719	720	1100	1100	140
64020	530	202	257	0.027514	720	1100	1100	140
67018	529	233	258	0.027514	480	1100	1100	140
68024	529	233	258	0.031800	480	1100	1100	140
70027	534	286	257	0.031800	480	1100	1100	140
72025	534	286	257	0.039250	480	1100	1100	140

▼ MOTORCYCLE Battery Packaging



BATTERY TYPE	BOX DIMENSION (mm)			VOLUME M ³	BATTERY QTY. PER 20FT CONTAINER	PALLET DIMENSION (mm)		
	LENGTH	WIDTH	HEIGHT			LENGTH	WIDTH	HEIGHT
GM3-3B/YB3L-3B	335	252	148	0.012494	22400	1100	1100	140
GM4-3B/YB4L-3B	405	296	130	0.015584	14400	1100	1100	140
GM5Z-3B/YB5L-3B	355	294	167	0.017430	10800	1100	1100	140
12N5-3B	355	294	167	0.017430	10800	1100	1100	140
12N10-3B	505	328	182	0.030146	5400	1100	1100	140

Box Dimension

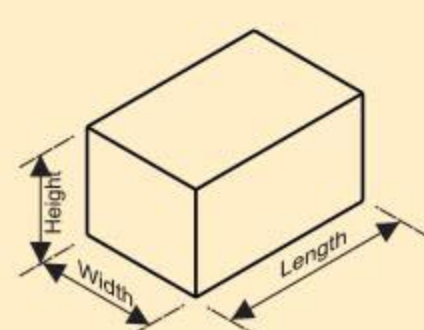

Pallet Dimension

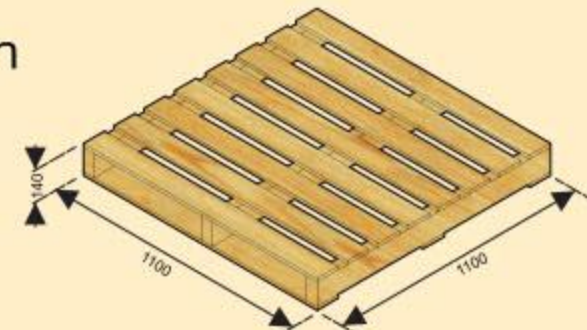

- Storage :
- . Keep batteries upright.
 - . Do not expose to direct sunlight.
 - . Keep batteries clean and always store in a cool & dry place.
 - . First In - First Out (FIFO) storage procedure must be applied.

INSTRUCTIONS FOR STORAGE AND INSTALLATION

STORAGE

- . Keep batteries upright.
- . Do not expose to direct sunlight.
- . Keep battery clean and store in a cool & dry place.
- . First In - First Out (FIFO) storage procedure must be applied.

BATTERY REPLACEMENT :

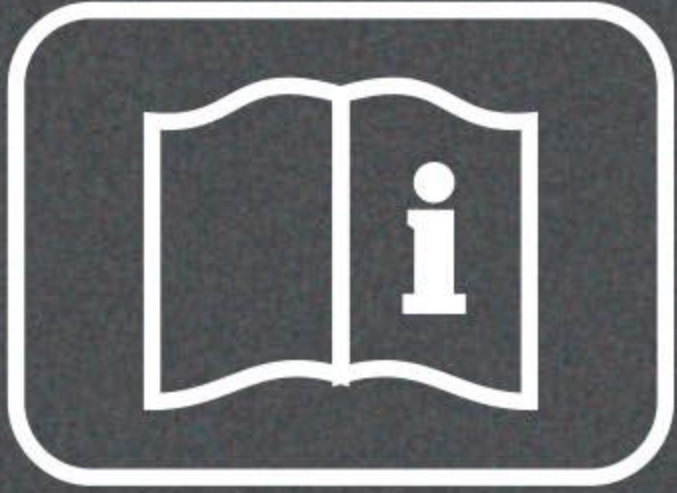

Read Instruction Manual.

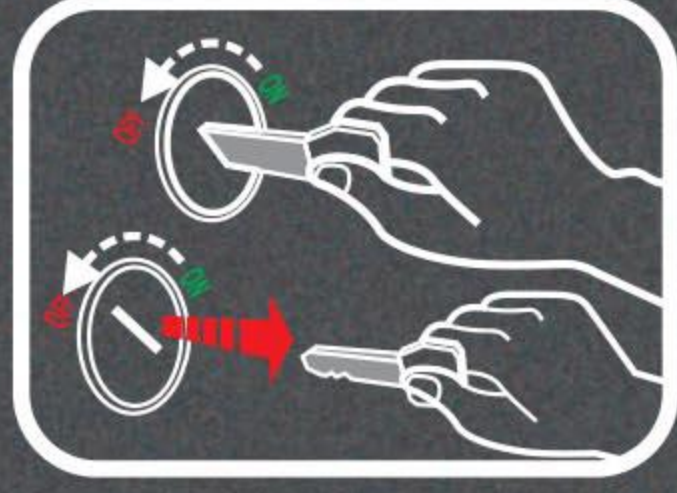

Make sure the engine is in " Off " condition and the key must be removed.

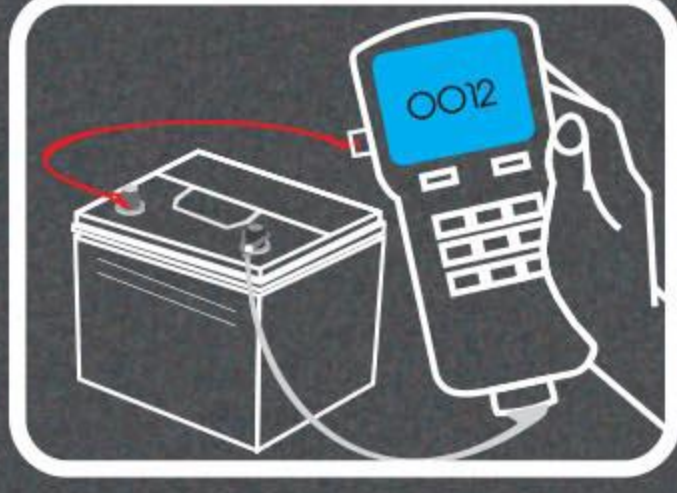

Should the battery voltage is less than 12.45V. Initial charging is recommended.

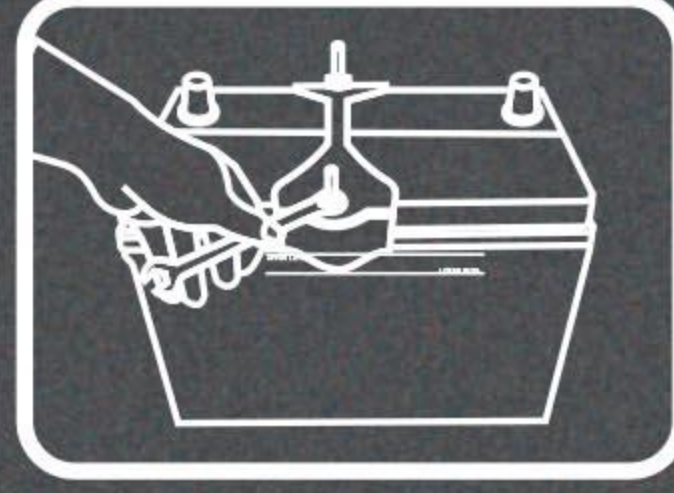

Place new battery on installing rack and secure it with tightening bolts.

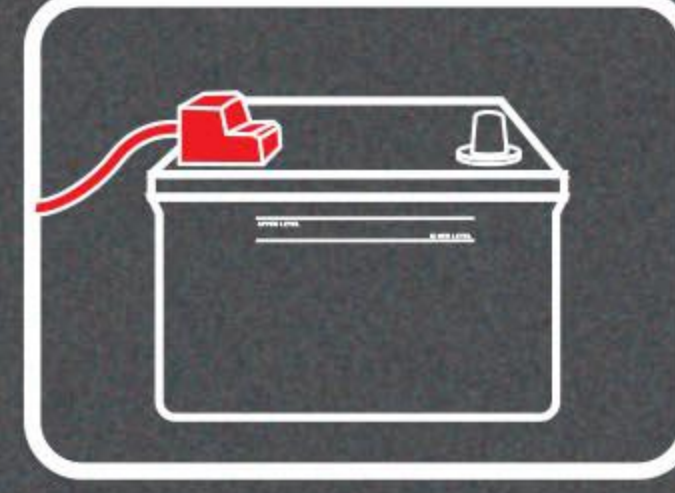

Connect positive cable with positive terminal first.

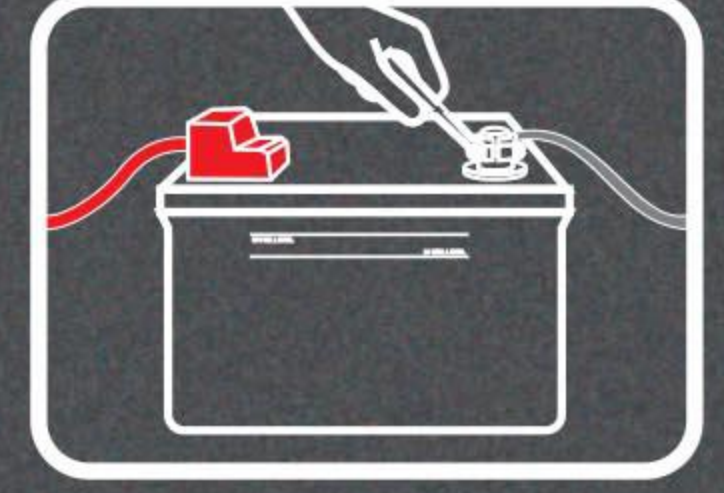

Connect negative cable with negative terminal.

* *Loosened cable may cause explosion, secure it tightly.*

MAINTENANCE

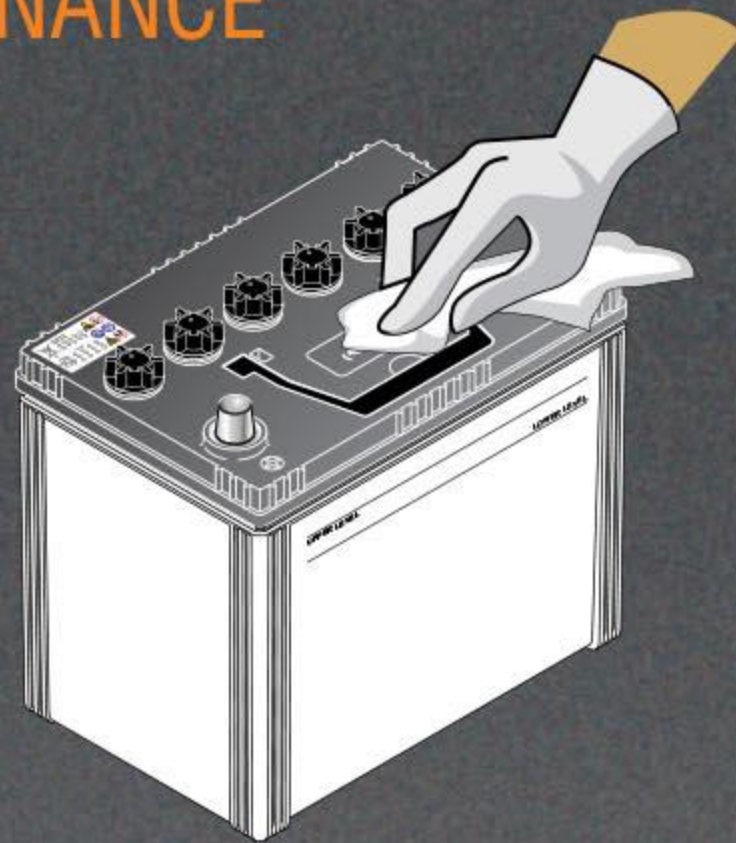

CLEANING

Keep the battery top cover dry clean and free from corrosion. Examine vent holes and exhaust tube to ascertain they are free from dirt or fold.

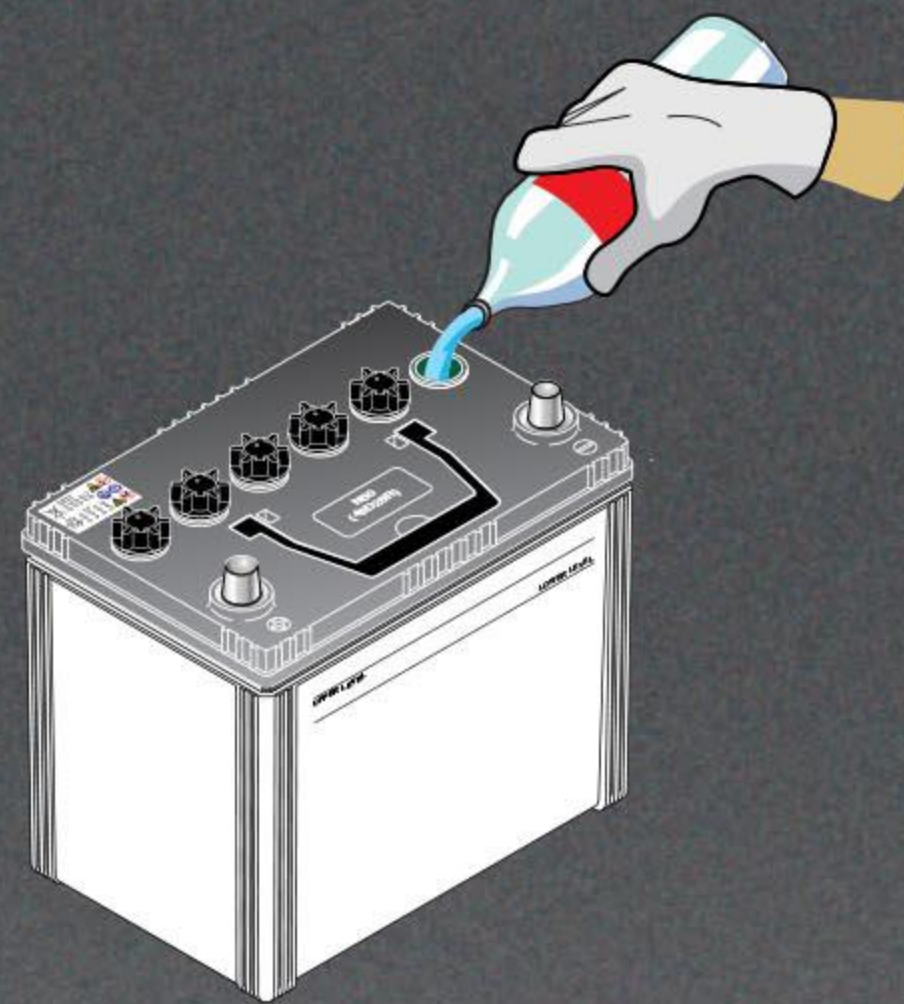

ADDING DISTILLED WATER

If electrolyte level is lower than the " LOWER LEVEL " add some distilled water until reaches the " UPPER LEVEL " mark.

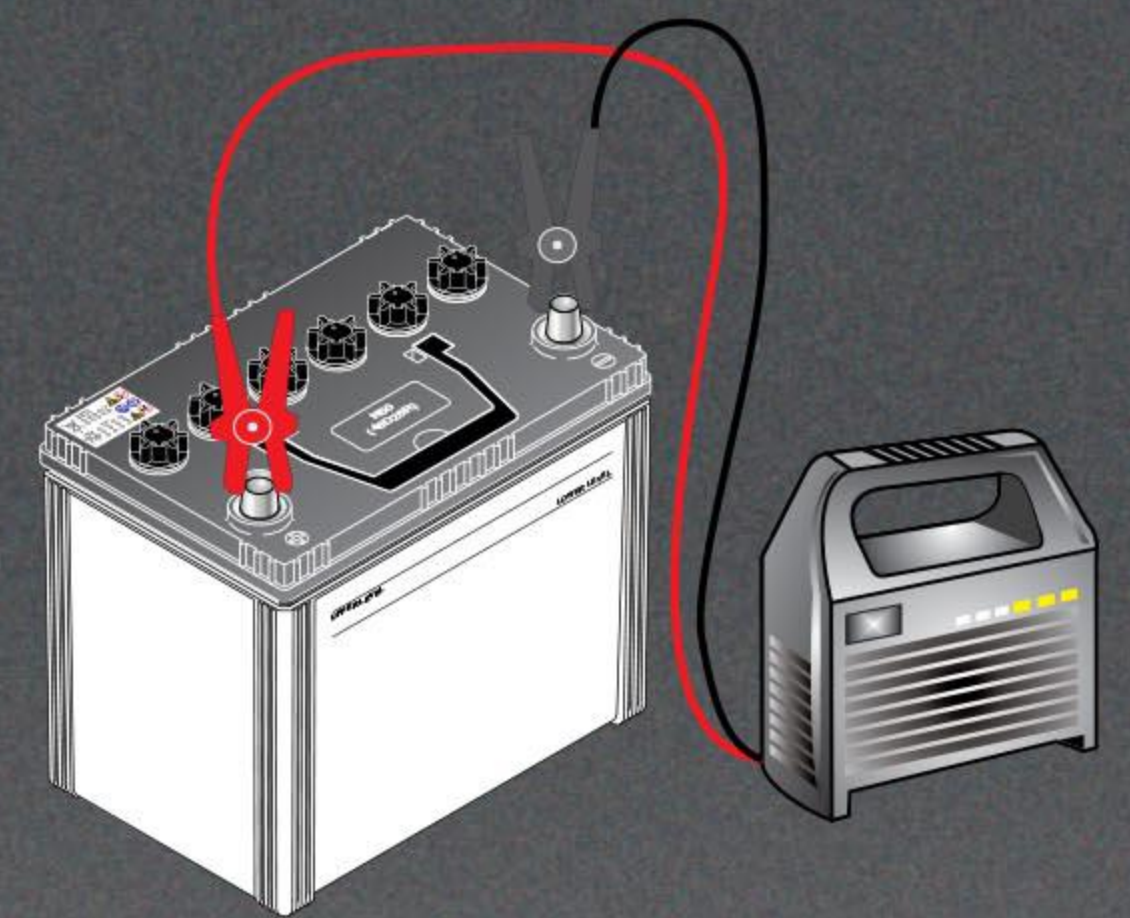

WHEN IS ADDITIONAL CHARGING REQUIRED ?

If the gravity of electrolyte is lower than 1.220.

GENERAL INFORMATION ON BATTERY SAFETY

Battery acid can cause burns

Use extreme care when handling acid. If electrolyte is spilled or splashed onto clothing or body, wash with water and neutralize with a solution of baking soda and water. Electrolyte splashed into eyes is extremely dangerous. If this occurs, gently open eyes and wash with cool clean water for 5 minutes, call a doctor for further examination.

If electrolyte is swallowed

Drink large amount of water or milk and follow with milk of magnesia, beaten eggs or vegetable oil, call a doctor for further examination.

If it is necessary to prepare electrolyte

Always add concentrated acid to water - never water to acid. Store electrolyte in plastic containers with sealed cover.

Explosive battery

Batteries generate explosive gases during vehicle operation and when charged separately. Flames, sparks, burning cigarettes or other ignition sources must be kept away at all times.

Caution, always shield eyes when working near battery.

When charging batteries, work in well ventilated area, never in a closed room. Always turn battery charger or ignition off before disconnecting a battery.